

Instructions



060R9513

Differential pressure controls MP 54, MP 55, MP 55A

MP 54, MP 55: CFC, HFC, HCFC
 MP 55A: R 717 (NH₃), CFC, HFC, HCFC

060R9513

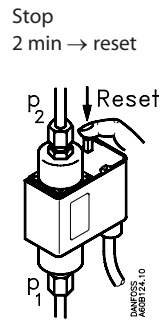
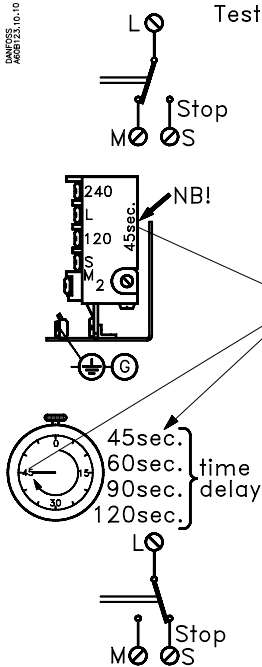
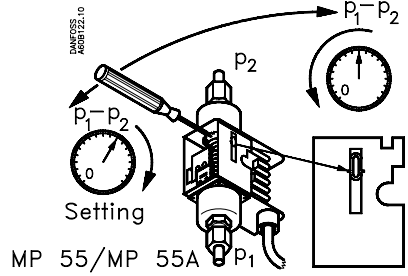
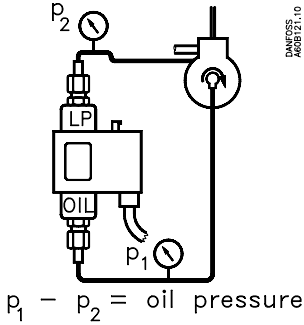

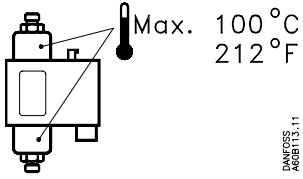

DANFOSS
A60B113.11

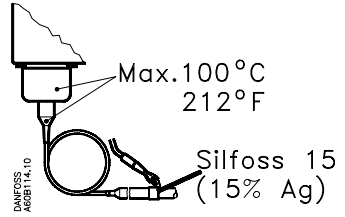

DANFOSS
A60B114.10

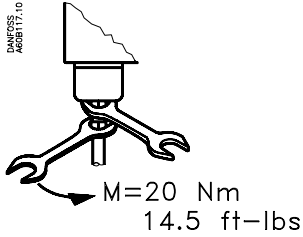

DANFOSS
A60B117.10

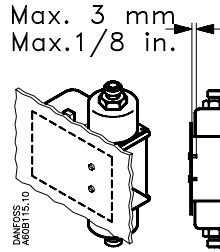

DANFOSS
A60B115.10

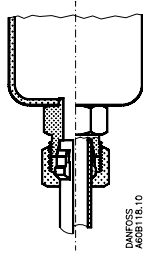

DANFOSS
A60B116.10

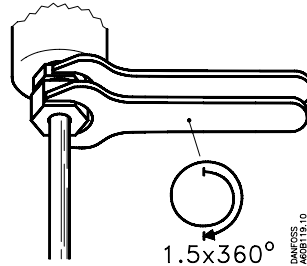

DANFOSS
A60B118.10

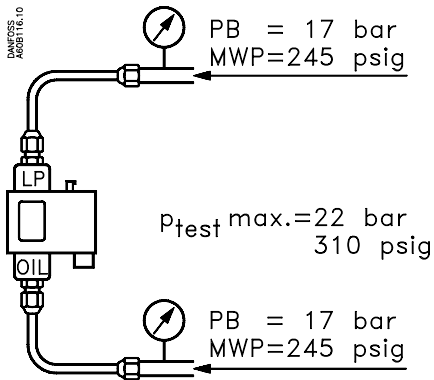

DANFOSS
A60B116.10

LP

OIL

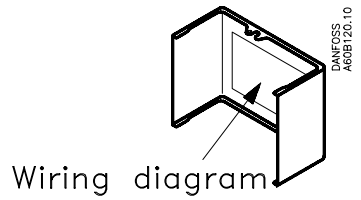

DANFOSS
A60B120.10